

Operating Instructions

TCM 1601

Magnetic Bearing Controller



Index

	Page		Page
1. Safety Precautions.....	3	6. Operations.....	16
2. Understanding The TCM 1601	4	6.1. Switching ON The Unit.....	16
2.1. For Your Orientation.....	4	Self-Testing.....	16
2.2. Product Description.....	4	6.2. Switching ON The Pumping Station.....	16
Connection Options	4	Normal Operations, Turbopump	16
Proper Use	4	6.3. "Standby" ON/OFF	16
Improper Use	4	6.4. Housing Heating ON/OFF	16
2.3. Description Of The Front Panel.....	5	6.5. Temperature Management Operations (TMS).....	16
2.4. Description Of The Rear Panel	5	6.6. Air Cooling ON/OFF	17
2.5. Abbreviated Overview, Operating	5	6.7. Gas Mode Operations	17
3. Installation.....	6	6.8. Switching The Turbopump ON or OFF	17
3.1. Preparations For Installation.....	6	6.9. Rotation Speed Setting Operations.....	17
3.2. Connections Diagram.....	6	Rotation Speed Setting via Inlet PWM.....	18
3.3. Fitting The Unit In A Rack	6	6.10. Pumping Control Unit Operations with TCS 180.....	18
3.4. Mains Power Connection	6	Pressure Measurement.....	18
3.5. Connecting The Pump And The Venting Valve	7	Pressure Set Value	18
3.6. Connecting The Pump Heating Or Air Cooling Units....	7	High Vacuum Valve Controlling	18
3.7. Connecting The Pumping Station Control Unit.....	7	Operation Backing Pump.....	19
3.8. Connecting The Temperature Management		6.11. Switching OFF The Pumping Station.....	19
System (TMS)	7	6.12. Switching On The Electrical Brake	19
3.9. Connecting The Remote Control Unit	8	6.13. Remote Control.....	19
3.10. Potential Free Contacts.....	8	Remote Control Operating Modes.....	19
Functions Of The Switch Contact K1	8	6.14. Venting The Turbopump.....	20
Functions Of The Switch Contact K2	8	6.15. Serial Interface RS 485 Operations	21
3.11. Connecting The Pressure Gauges	9	6.16. Emergency Power Operations.....	21
3.12. Connecting The Serial Interface RS 485	9	6.17. Emergency Power Operations	
3.13. Connecting The Serial Interface RS 232	9	With Battery Box TBB 001	21
3.14. Connecting The External Battery Box TBB 001.....	9	7. Error Messages And Warnings.....	22
4. Operating And Display Elements.....	10	8. What To Do In The Case Of	
4.1. Operating Elements	10	Breakdowns ?.....	23
4.2. Display Elements.....	11	9. Maintenance, Service	23
LC Display.....	11	10. Technical Data.....	24
4.3. Abbreviated Overview Operating	12	10.1. Data List, Magnetic Bearing Electronic TCM 1601.....	24
4.4. Operating Examples.....	12	10.2. Dimensions Diagram	24
Illuminated Displays	13	11. Connections Diagram	25
Operations Messages (Line 3)	13	12. Accessories	26
5. Parameters.....	13	13. Supplementary Information.....	26
5.1. General	13	Manufacturer's Declaration	annex 1
5.2. Parameter Overview, Numerical.....	14		
5.3. Parameter Overview, Operational.....	15		

1. Safety Precautions

- ☞ Read and follow all the instructions in this manual.
- ☞ Inform yourself regarding:
 - Hazards which can be caused by the unit,
 - Hazards which can arise in your system,
- ☞ Comply with all safety and accident prevention regulations.
- ☞ Check regularly that all safety requirements are being complied with.
- ☞ Take account of the ambient conditions when installing the TCM 1601. The protection type is IP20. The unit is protected against the ingress of foreign bodies $\geq \varnothing 12$ mm. Because water protection is not provided the unit must be fitted into a suitable housing (please see Section 3. Installation).
- ☞ Do not carry out any unauthorised conversions or modifications on the unit.
- ☞ Neither disconnect the cable on the TCM during operations nor in the event of a malfunction.
- ☞ The pump re-starts automatically after restoration of power after a mains power failure.
- ☞ Ensure that the cable insulation is not damaged.
- ☞ Do not open the housing cover when the unit is connected to the mains nor during pumping operation.
- ☞ Take account of the prescribed voltage when connecting the cable to the various plugs.
- ☞ Ensure that the cable lines are correctly positioned so that no damage can occur. Do not lay cable over sharp edges or hot surfaces.
- ☞ The unit must only be operated within the prescribed voltage range (see Section 3.4.).
- ☞ The unit must not be used as a table unit without a surface.
- ☞ Use only mains switches with earthing conductors (PE; Protection class 1).
- ☞ Protect the unit against thermal overloading.
- ☞ Neither disconnect the connector plug on the unit nor on the turbopump during operations and nor before the pump is completely at rest.
- ☞ When returning the unit to us please note the shipping instructions (please see Section 9).

Pictogram Definitions



Danger of an electric shock.



Danger of personal injury.



Danger of damage to the unit or system.

Corrections reserved!

2. Understanding The TCM 1601

2.1. For Your Orientation

Symbols Used

The following symbols are used throughout in the illustrations:

- ⊕ High vacuum flange
- ∇ Fore-vacuum flange
- ⊖ Venting connection
- ⊗ Cooling water connection
- ⚡ Electric connection
- ⊕ Air cooling

Position Numbers

Identical accessory parts have the same position numbers in all illustrations.

Operating instruction In The Text

➔ Here, you have to do something.

Text Definition (Example)

[P:701] = Parameter number, choosable
«Param. Set» = Parameter description
SPC = Stored Program Control

2.2. Product Description

The Magnetic Bearing Controller TCM 1601 serves to drive and monitor PFEIFFER turbomolecular pumps.

The following components are included on delivery:

- TCM 1601.
- Mating plugs for X16

The Magnetic Bearing Controller TCM 1601 contains the following functional units:

- Electronic drive monitoring and controlling.
- Monitoring and controlling for the magnetic bearing.
- LC display with information on the operations status of the pump.
- Parameter selection and adjustment
- Power failure electronics
- Serial Interface RS 485
- Remote control
- potentialfree contacts K1, K2
- external connection for battery box TBB 001

Battery box TBB 001 serves as a supply source for the magnetic bearing in emergency power operations up to the reduction of the rotation speed to 0 Hz (see 12. Accessories).

Connection Options:

The following connection options are available on the TCM 1601:

- Remote control (X16).
- Pumping Station Control Unit TCS 180 (X41)
- Host computer via Serial Interface RS 485 (X17)
- Heating, turbopump housing (X6).
- Air cooling for turbopump (X6).
- Operations monitoring, TMP (X20).
- Temperature Management System TMS 001 (X6)
- Battery box TBB 001 (X29).

The unit has been tested and cleared by the appropriate authorities in accordance with EN 61010/VDE0411 "Safety Ordinance For Electrical Units".

Pumping Station Control Unit TCS 180

With the Pumping Station Control Unit TCS 180 components can be operated as follows:

- Backing pump (Intermittent operations in respect of the diaphragm pumps).
- Fore-Vacuum Safety Valve (TVV 001) to prevent venting via the backing pump.
- High vacuum valve.
- High vacuum gauge head.

Proper Use:

- The Magnetic Bearing Controller TCM 1601 may only be used to drive and monitor PFEIFFER magnetic bearing turbomolecular pumps.
- The operations unit TCM- turbopump may only be operated together with a backing pump.
- Instructions concerning installation, start-up, operating and maintenance must be observed.

Improper Use:

Improper is:

- Uses not covered above, and, in particular,
- Connection to pumps and units which is not permitted in their operating instructions.
- Connection to units which contain touchable and voltage carrying parts.

Improper use will cause any rights regarding liability and guarantees to be forfeited.

2.3. Description Of The Front Panel

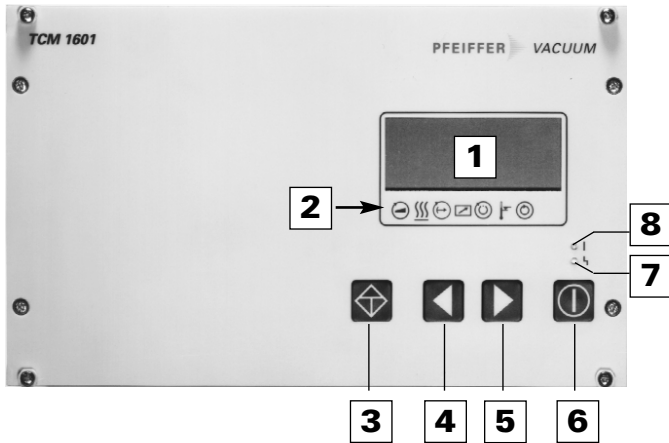

All operating and display elements are located on the front panel.

- 1 LCD display
- 2 Status display
- 3 Push-button "Malfunction Acknowledgment"
- 4 Push-button parameter selection "backwards"
- 5 Push-button parameter selection "forwards"
- 6 Push-button "Pumping Station ON/OFF"
- 7 Red illuminating diode for the error status
- 8 green illuminating diode for the operations status

2.4. Description Of The Rear Panel

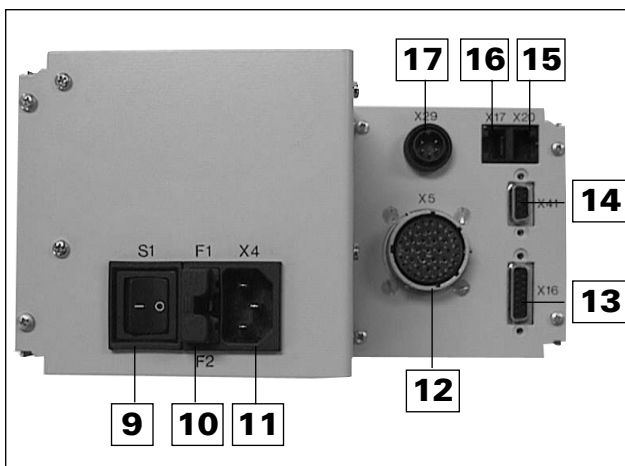

On the rear panel are plug connections for the various connections, mains switch and fuses.

- 9 Mains Switch S1
- 10 Fuses F1,F2 (10 AF)
- 11 Mains connection X4 (90-132/190-265 V~)
- 12 Connection socket, pump X5
- 13 Connection socket, Remote X16
- 14 Connection socket, pumping stat. control TCS 180 (X41)
- 15 Potential free contacts X20 (relay controls)
- 16 Serial Interface RS 485 / X17
- 17 Connection socket Battery box X29

2.5. General Description Of The Unit

The Magnetic Bearing Electronic Unit TCM 1601 contains a number of monitoring and control options for your vacuum pump and for the pumping process. It can be operated via the keypad, serial interface or remote control.

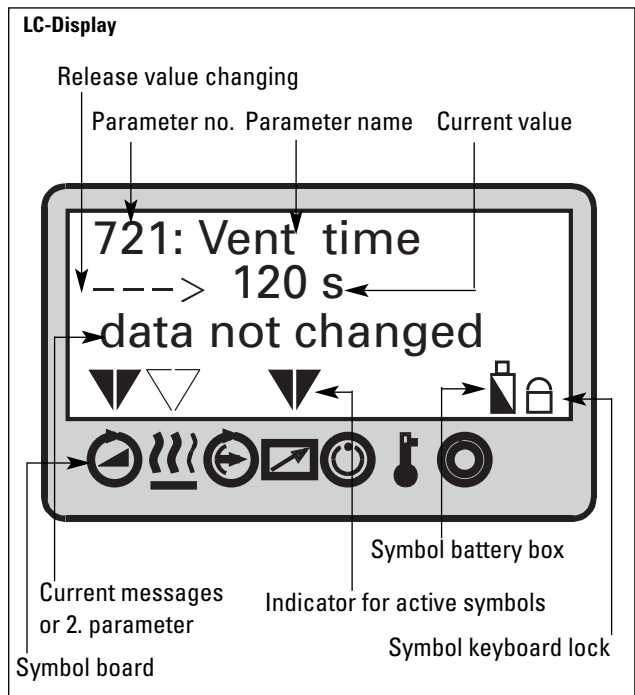

The LC display enables the representation of various operating conditions. The influence on the vacuum components and their operational behaviour is controlled via parameters; this means via specific numeric combinations to which are assigned functions. The parameters which can be selected are explained in the parameter lists in Sections 5.2. and 5.3.

Parameters sets

The parameters can be called up from three different parameter sets (please also refer to the explanation in Section 5.1.).

- Basic parameter set
- Extended parameter set
- Operational orientated parameter set

Parameter groups

The parameters are classified in three groups.

- Setting commands
- Status requests
- Set values

Works settings can be retained or you have the option to enter your own settings under setting commands and set value specifications. Please follow the procedure outlined in Section 6, "Operations" when undertaking pre-setting or when modifying operational modes.

Please refer to Section 6.14. for operations via remote control. Serial interface operations are described in Section 6.16.

3. Installation

3.1. Preparations For Installation



Unauthorised modifications or alterations to the magnetic bearing controller unit are not allowed.

The unit must be fitted in a housing taking account of the ambient conditions (see Section 10, "Technical Data").

Please refer to section 11 for the electrical connections diagram.

➔ Disconnect mains power before installation work.

3.2. Connections Diagram

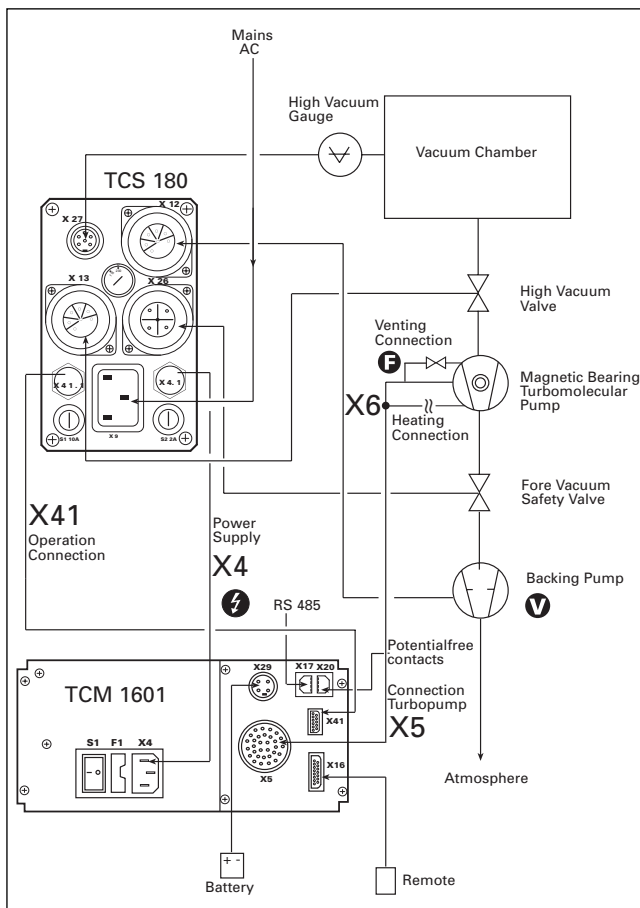

Take account of the following ambient conditions when installing the TCM 1601.

Installation location: Protected against the weather.

The following is applicable for open buildings and operations rooms which are not fully air conditioned:

Temperature: +5°C - +40°C.
Relative humidity: 5 - 85%, non-condensing.
Air pressure: 86 kPa - 106 kPa

3.3. Fitting The Unit Into A Rack

To fit into a 19" rack housing, the unit should be inserted into a 19", 3HE frame in accordance with the specifications and secured.

The ambient temperature in the rack casing should not exceed 40°C.

The unit may only be fitted into racks which comply with the prescribed safety protection regulations.

Cooling/Air Circulation

The Magnetic Bearing Control Unit TCM 1601 generates dissipation power of 200W. Adequate air circulation must be provided around the unit to conduct away this power.

3.4. Mains Power Connection

- The unit has been designated protection class 1 and must therefore always be connected with the earthed conductor (PE).
- Mains connection must be made in accordance with the local regulations.



Danger of an electrical shock.

The mains voltage on X4.2 can be in the range 90-132/190 - 265 V. Mains voltage commutation for the TCM 1601 is not necessary.

- ➔ Plug mains cable into X4.
- ➔ Install mains connection.
- ➔ If a Pumping Station Control Unit TCS 180 is in use, make the mains connection via the TCS (see chapter 3.7. and the connections diagram PM 041 892 -S, chapter 11.).



Where large turbomolecular pumps are involved, the drive power can be limited in the 100V range (please see the operating instructions for the pump).

3.5. Connecting The Pump And The Venting Valve



Voltages of up to 50 V_{eff.} can be present on the open connection of a running down pump.

There is a danger of an electric shock by touching the contacts.

- ➔ Connect the turbomolecular pump with connecting cable (52) to X5/TCM 1601.
- ➔ Lock the bayonet catch (51, 53) on the pump after plugging in.
- ➔ Connect the cable splice X1 of the TCM connecting cable to the venting valve (54) and lock it with a screw.

Only PFEIFFER connecting cable should be used for connecting the pump.

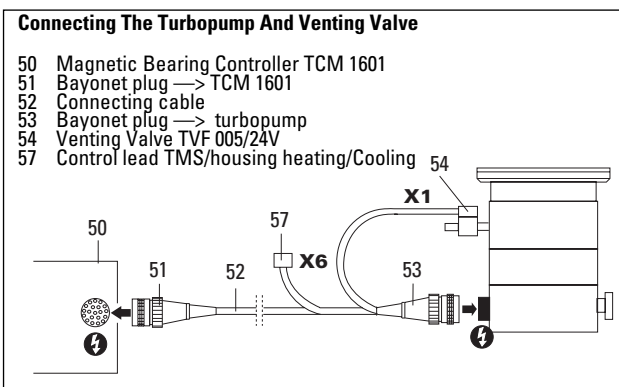

Only disconnect the plug connector to the magnetic bearing controller once the pump is completely at rest and the unit has been disconnected from the mains power supply.

3.6. Connecting The Casing Heating Or Air Cooling Units To The Turbopump

Casing heating

- ➔ Fit the casing heating unit in accordance with the operating instructions.
- ➔ Connect the relay box control lead to X6.
- ➔ Connect the casing heating unit to mains power.

Air Cooling

- ➔ Fit the air cooling unit in accordance with the operating instructions.
- ➔ Connect the relay box control lead to X6.
- ➔ Connect the air cooling unit heating to mains power.

3.7. Connecting The Pumping Station Control Unit TCS 180 (optional)

- ➔ Connect the Pumping Station Control Unit TCS 180 in accordance with connections diagram section 3.2.
- ➔ Use the mains cable from the TCM 1601 for the TCS 180 mains connection.
- ➔ Connect cable connection X4.1/TCS 180 with X4/TCM 1601.
- ➔ Connect cable connection X41.1/TCS 180 with X41/TCM 1601.

No other units may be connected to X4/TCM 1601.

Further notes regarding the connection of Pumping Station Control Unit can be found in the operating instructions for the TCS 180 (PM 800 384 BN).



Only disconnect the plug connector to the Pumping Station Control Unit TCS 180 once the pump is completely at rest and the unit has been disconnected from the mains power supply.

3.8. Connecting The Temperature Management System (TMS)

The connections for heating and sensors are centrally accessible in the TMS connecting box. The installation is described in the installation instruction PM 800 570 BN.



When the TMS is in operation additional housing heating of the turbomolecular pump is not possible. When the TMS is in operation the pump must be water cooled.

3.9. Connecting The Remote Control Unit

The TCM 1601 or the complete pumping station can be remote controlled via plug X16. Before connecting the remote control, the remote mode should be selected (please refer to Section 6.14.).

- ➔ Connect the remote control in accordance with the required functions to mating plug X16 (cable) as per the connections diagram PM 041 892 -S (see Section 11).

Pin Arrangement X16

Pin	Description	Function	Typ
X16.1	+15 V	–	–
X16.2	U _F	frequency proportional analog voltage (0 - 10V DC)	voltage output
X16.3 ¹⁾	PWM ²⁾ Turbo-rotation speed	set value for turbopump in the range of 20 - 100% of the max. turbo rotation speed	PWM-Input: basic frequency 100 Hz (± 20%) pulse-duty factor: 25 - 75%
X16.4	–	–	–
X16.5	–	–	–
X16.6 ³⁾	Heating "ON"	TMS "ON" or housing heating "ON" pre-selected	digital Input (statal signal)
X16.7	Remote Priority "ON"	switch on Remote Priority (keyboard and interface out of function)	digital Input (statal signal)
X16.8	–	–	–
X16.9 ³⁾	Standby "ON"	Turbo rotation speed reduce to 66% of the maximum rotation speed	digital Input (statal signal)
X16.10 ³⁾	Pumping station "ON"	switch on pumping station	digital Input (statal signal)
X16.11 ³⁾	Turbopump "ON"	Preselect turbo drive "ON" (drive current is switched on, if pumping station is switched on).	digital Input (statal signal)
X16.12	–	–	–
X16.13 ³⁾	Reset "ON"	delete of an error-message	digital Input (pulse)
X16.14 ³⁾	Release pump venting	pump venting released after pre-selected vent mode)	digital Input (statal signal)
X16.15	0V	reference ground for all in and outputs of plug X16	

- 1) Connection by setup of the PWM; compatibel to Stored Program Control (SPC).
Function can be aktivated by a signal level from a SPC (see chapter 6.10).
2) PWM = puls-width modulation
3) SPC compatibel or connect the PIN with PIN X16.1.

3.10. Connecting The Potential Free Contacts

The switching contacts K1 and K2 on X20 are available. They can be used for external monitoring of the turbomolecular pump. Connection is as per Connections Diagram PM 041 892-S. The contacts can be loaded as written in sect. 10.1. "Technical Data".

Pin Arrangement X20

Pin	Description	Function
X20.1	K1	Closer
X20.2	–	–
X20.3	K1	Closer
X20.4	K2	Closer
X20.5	–	–
X20.6	–	–
X20.7	–	–
X20.8	K2	Closer

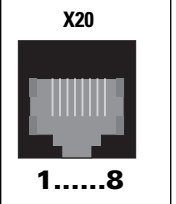

Switch Contact K1 Functions

The functions are set via «024 : Conf Out1».

The potential free contact possesses three adjustable functions:

Function 0/setting 0: rotation speed switchpoint monitoring

→ Contact is open, if the turbo rotation speed is less than/the same as the rotation speed switchpoint [P:701].

→ Contact is closed if the turbo rotation speed is greater than the rotation speed switchpoint.

Function 1/setting 1: TMS temperature monitoring

→ K1 is closed as long as TMS temperature is in the tolerance range of ±5K of the selected temperature.

Function 2/setting 2: Pumping operations and rotation speed switchpoint monitoring

→ Contact is open if the turbo rotation speed is less/the same as the rotation speed switchpoint [P:701] or the drive has been switched off via «010 : Pump stat.» or «023 : Motor TMP» or via malfunction identification.

→ Contact is closed if the turbo rotation speed is greater than the rotation speed switchpoint and the pump drive is switched on.

Switch Contact K2 Functions

The potential-free switch contact K2 possesses three settable functions which are set via «019 : Conf Out2».

Function 0

- ➔ Select «019 : Conf Out2» and set to «0».

The contact is open in the following situations:
In unit mode "Netz AUS" (power OFF) or In error status (display "Exxx")

Function 1

- ➔ Select «019 : Conf Out2» and set to «1».

The contact is open in the following situations:
- In unit mode "Netz AUS" (power OFF).
- In error status (display "Exxx") or warning status ("Fxxx").

Function 2

- Select «019 : Conf Out2» and set to «2».

The contact is open in the following situations:

- In unit mode "Netz AUS" (mains OFF).
- With "Netz EIN" (mains ON) with
 - «023 : Motor TMP» to "OFF" or
 - «010 : Pump stat» to "OFF".
- In error status (display "Exxx").

3.11. Connecting The Pressure Gauges

Any one of the pressure gauges listed in the above table can be connected to X27/TCS 180. They are recognized automatically by the TCM 1601.

Pressure Gauge	p_{min} / mbar	p_{max} / mbar
TPR 250 (HVV)	5E-4	1E+3
IKR 250	2E-9	1E-2
PKR 250 (HVV)	5E-9	1E+3
ACR 261 (HVV)	1E-1	1E+3
ACR 262 (HVV)	1E-2	1E+2
ACR 263 (HVV)	1E-3	1E+1

Gauges marked "HVV" are appropriate, in connection with TCS 180, for controlling high vacuum valves (see section 6.11).

3.12. Connecting The Serial Interface

The serial interface contact is made with a RJ45 plug (Western plug) via X17 on the rear side of the unit.

Physical Connection

Connection plug arrangement X17

Description	Value
Serial Interface Type:	RS 485
Baudrate:	9600 baud
data word lengths:	8 bit
Parity:	no parity
Startbits:	1
Stopbits:	1..2

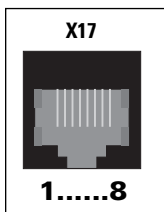

PIN	Arrangement
1	not connected
2	+15V output ($\leq 150\text{mA}$ loading capacity)
3	not connected
4	not connected
5	RS 485: D+ (DO / RI)
6	gnd
7	RS 485: D- ($\overline{\text{DO}}$ / $\overline{\text{RI}}$)
8	not connected

An RS 485 bus can be assembled as in the following example. By means of a standard Western plug connector, cable and cross-over network the signals are looped from one unit to the next. The bus is terminated at both ends (RT and RT*) and maintained at approx. 200mV via a voltage divider (R1 and R2).

The resistance values are dependent on the cable and the application. Typically, the values involved are $R1=R2=680\Omega$; $R_T=130\Omega$. The +5V supply voltage must be either connected externally or be provided by several units themselves. This must then be connected to one end of the bus with the other end only terminated with R_T .

Connecting to a fixed bus system:

➔ Connect all units with D+ (pin 5) and D-(pin7) to the bus.

The bus must be connected at both ends with R_T .

Networking several units:

➔ Continue the loops by means of a T piece.

The bus must be connected at both ends with R_T .

All units connected to the bus must have differing serial interface addresses [P: 797].

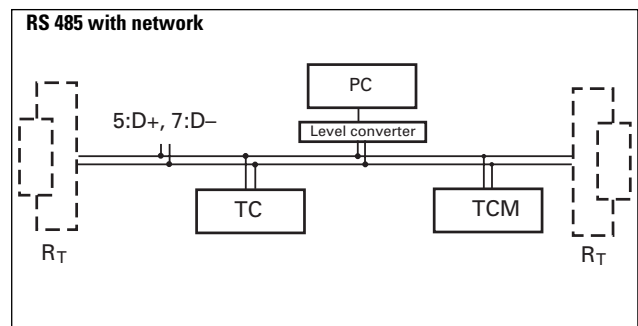

Only safety low voltages (SELV) may be connected to Serial Interface RS 485 (X17).

3.13. Connections of the RS 232 Interface

The connection of an RS 232 Serial Interface is possible via a Level Converter (see 12, Accessories). The converter is equipped with a 9 pole D-SUB plug connector, an RJ45 Western Plug and a connecting cable.

➔ Connect the level converter to X17/TCM 1601 by an equivalent cable.

3.14. Connecting The External Battery Box TBB 001

















➔ Connect battery box TBB 001 (with battery 2x12V/2.1Ah, lead gel) to plug connection X29/TCM 1601.

➔ Connect battery box TBB 001 with mains cable to the mains.

4. Operating And Display Elements

4.1. Operating Elements

The four push-buttons on the front panel have the following functions:

Push-Button	Application/Example	Explanation
		Reset (malfunction acknowledgement) acknowledges malfunctions (red LED illuminates)
	 309: Act rotspd  310: TMP I-Mot	Scroll Parameters Backwards scrolls a parameter backwards
	—>	 50%  49%
	 310: TMP I-Mot  311: TMP Op hrs	Scroll Parameters Forwards scrolls a parameter forwards
	—>	49%  50%  ...
 	001: Heating  off	Alters Values (⇒ data editing mode) access to a displayed value, if possible (arrow “—>” appears)
	simultaneous-ly —>	001: Heating off ✓
	010: Pump stat. on ⇄ off	Pumping Station ON/OFF switches the pumping station ON or OFF, corresponding to Parameter 010: “Pump stat.”

The following should also be noted:

-The data editing mode (arrow “—>” is displayed) is automatically exited under the following conditions, without taking over the possible altered value:

- if no push-button is depressed for approximately 10 seconds.
- an error occurs.

4.2. Display Elements

LC Display

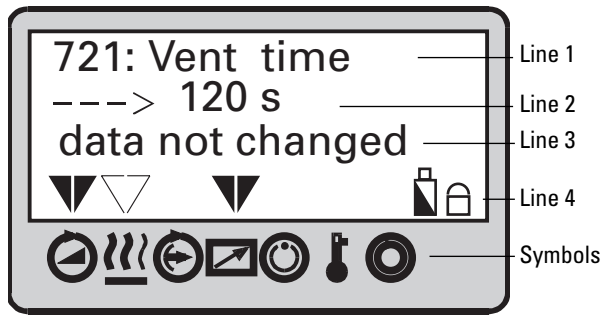

The display of the functions is shown via a four line LC display. In normal operations a specific function is assigned to each line:

- **Line 1:** Number and name of the selected parameter (e.g. «721: Vent time»).
- **Line 2:** relevant value. In the data editing mode [P:795] an arrow (--->) is displayed left. The value can now be altered.
- **Line 3:** With two functions,
Function 1: Actual messages which refer to operation and control appear (see table “Operating Messages (line 3)” on the next page.
Function 2: An optional second parameter in the form «Parameter number»: «Value» is displayed. The function of this line is set via «725: Servicelin»: The value «795» allows actual messages to appear.

Error messages/ warning messages overwrite the selected value of the parameter.

- **Line 4:** Arrows which point to the underlying symbols. These restore the unit status.

Symbols "keyboard lock" and "battery box connected".



Symbol Definitions

Symbol	Meaning	Display	Explanation
	Pump	–	No
	accelerates	▼	YES
	Pre-selection housing-/ TMS-heating	–	OFF
		▽	Pre-selection heating ON
		▼	Heating ON
	Standby	–	OFF
		▼	ON
	Unit	–	NO
		▼	YES
	Rotation switchpoint attained	–	NO
		▼	YES
	Excess temperature	–	NO
		▽	Excess temperature TMP
		▼	Excess temperature Magnetic Bearing Elektronik
	Excess temperature	–	NO
		▽	Excess temperature TMP and Magnetic Bearing Elektronik
		▼	Excess temperature TMP and Magnetic Bearing Elektronik
	Final rotation speed attained	–	NO
		▼	YES
	Keypad lock		ON, operation locked via keys
	Battery box		Battery box connected. No statement with regard to the charge level of the battery.







4.3. Abbreviated Overview, Operating



Selecting Parameters

- ➔ Selecting parameters with push-button  (backwards) or  (forwards). Keeping the key depressed enables rapid scrolling.

Setting Parameters

- ➔ Select Parameter.
- ➔ Depress key-button  and  simultaneously till an arrow (--->) will appear in the second line from the top.
- ➔ With key-button  reduce the value and with key-button  increase the value.
- ➔ Depress key-button  and  simultaneously till the arrow (--->) disappears. The set values are now taken over.

Error acknowledgement

Depress key-button  for a duration of min. 2 seconds.

Switching ON and OFF the pumping Station

Depress key-button .

Operating Examples

Switching on the magnetic bearing controller

- ➔ Switch on the unit on the rear side with switch S1.

Switching on the pumping station

- ➔ Select «794: Param. Set» and set to «1»
- ➔ Check set values [P:7xx] and setting commands [P:0xx]

Casing heating ON/OFF

- ➔ Select «018: Conf. OUT3» and set to «1».
- ➔ Select «001: Heating» and set to «1».

Switching off the turbopump

- ➔ Select «023 : Motor TMP».
- ➔ Select «OFF».

Switching off the pumping station

- ➔ Press key-button  on the front panel.

Illuminated Displays

The red LEDs (error status) and green LEDs (operations status) on the front panel can assume the following conditions:

	Red LED	Green LED
Illuminates:	Collective error message	Mains ON, pumping station ON [P:010]
Flashes short: (1/12s active)	Warning	Mains pack ON, pumping station OFF [P:010]
Blinks: (1/2s active)	Turbopump vibration	Mains power failure

Operations Messages (Line 3)

Independent to the adjustments «**795: Servicelin**» to «**0**»

Message	Meaning
** Error Exxx **	Error xxx has occurred
* Warning Fxxx *	Warning xxx has occurred

Adjustment «**795: Servicelin**» to «**795**» (overwrite by error messages/warning messages)

Message	Meaning
data read only !	Attempted access to read only parameter
data not changed	Data editing mode has been quit without taking over altered values (e.g. settings are not confirmed before the expiration of a waiting period of approximately 10s).
change confirmed	Altered value entered
type invariable !	Recognized vacuum pressure gauge cannot be altered

5. Parameters

5.1. General

All function relevant sizes of the magnetic bearing controller are structured in the form of parameters. Each parameter has a number and a clear text designation

(e.g. «**026: OpMode TMP**»). There are three different parameter types:

Type of Parameter	Function
Setting commands	Activating/de-activating a controlling function
Status requests	Parameter status/value request (readable only)
Set values	numerical modifying of a value

The total of the available parameters represents a parameter set.

To adapt this parameter to the individual requirements of the

user the TCM 1601 provides three parameter sets which differ from each other in the number of parameters and their sorting. The respective parameter set can be selected via the parameter «**794: Param. set**».

Parameter set	Notice	Setting «794: Param. set»
Basic parameter set	Only basic function parameters sorted by number	0
Extended parameter set	Complete parameter set sorted by number	1
Parameter set, operational orientated	Complete parameter set sorted according to application criteria	2

5.2. Parameter Overview, numerical

Setting Commands (readable and writable)								
#	Display	Name, Description	min	max	fact. set.	RS 485 ¹⁾	Data typ ²⁾	
001	Heating	Pre-selection, heating. 0=OFF; 1=ON	OFF	ON	OFF ³⁾	R/W	0	
002	Standby	Standby 0=off; 1=on	OFF	ON	OFF ³⁾	R/W	0	
004	RUTime ctr	Run-up time monitoring, 0=OFF; 1=ON	OFF	ON	ON	R/W	0	
008*		Keyboard interlock			-	R/W	0	
009*		Error acknowledgement			-	W	0	
010	Pump stat	Pumping station ON/OFF	OFF	ON	OFF ³⁾	R/W	0	
012	Vent enab	Venting enable ON/OFF	OFF	ON	ON ³⁾	R/W	0	
013	Brake enab	Pre-selection brake 0=off; 1=on	OFF	ON	OFF	R/W	0	
018	Conf OUT3	Config. 1=casing heating, 2=TMS, 3=air cooling, 0=no function	0	3	0	R/W	7	
019	Conf. OUT2	Config. K2 0= open if mains OFF or failure, 1=dto. or warnings 2=open if mains OFF, turbo drive OFF or failure	OFF	ON	OFF	R/W	7	
023	Motor TMP	Motor Turbopump ON/OFF	OFF	ON	ON ³⁾	R/W	0	
024	Conf. OUT1	Config. output K1 0=switchp. attained; 1= TMS temp. attained (±5K) 2=switchpoint attained + turbo drive "ON"	0	1	0	R/W	7	
025	OpMode BkP	Operations mode backing pump, 0=non-stop; 1=intermittent	0	1	0	R/W	7	
026	OpMode TMP	Operations mode TMP 0=final rotation speed operations; 1=rotation speed setting mode	0	1	0 ³⁾	R/W	7	
027	Gas mode	Gas mode 0=heavy inert gases; 1=other gases	0	1	0	R/W	7	
028	Opmode rem	Remote operations mode 0=standard operations, 1=remote priority	0	1	0	R/W	7	
030	Vent mode	Venting mode 0=automatic venting ; 1=do not vent; 2=venting "ON"	0	2	0	R/W	7	
031	HiFlowCtrl	Monitoring rotor lifting in case of high gas flow; 0="OFF", 1="ON"	0	1	0	R/W	0	

Status request (only readable)								
#	Display	Name, Description	min	max	fact. set.	RS 485 ¹⁾	Data typ ²⁾	
300*		Unit remote controlled via X16			-	R	0	
302*		Rotation switch point attained			-	R	0	
303	Error code	Actual error code „no Err“, „Errxxx“ oder „Wrnxxx“			-	R	4	
304*		Over temperature Magnetic bearing controller			-	R	0	
305*		Over temperature turbopump			-	R	0	
306*		Set rotation speed attained			-	R	0	
307*		Turbopump accelerates			-	R	0	
308	Set rotspd	Set rotation speed TMP in Hz	0	1000	-	R	1	
309	Act rotspd	Actual rotation speed TMP in Hz	0	1000	-	R	1	
310	TMP I-Mot	Motor current TMP in A	0.00	10.00	-	R	2	
311	TMP Op hrs	Operating hours TMP in h	0	99999	-	R	1	
312	Drv Softw	Software version electronic drive unit	V 0.0	V 25.4	-	R	4	
313	TMP DClink	Motor voltage TMP in V	0.0	127.5	-	R	2	
315	TMP finspd	Final rotation speed TMP in Hz	0	1000	-	R	1	
316	TMP power	Motor power TMP in W	0	1000.0	-	R	1	
318		Battery box connected			-	R	0	
331	TMS ActTmp	Heating TMS, actual value in °C	0	255	-	R	1	
333	TMS steady	TMS regulator engaged (± 5K)	YES	NO	-	R	0	
334	TMS maxTmp	Maximum TMS temperature occurred in °C			-	R	1	
335	Heat type	Heating typ 0=convect. heating, 1=TMS, 2=cooling, 255 no heating	0	255	-	R	7	
340	Pressure	Actual pressure value in mbar	0	255	-	R	3	
349	Drv Name	Unit type electronic drive unit	1E-12	1E3	-	R	4	
360	Past Err1	Error storage, Position 1 (last error occuring)			CM1601	R	4	
361	Past Err2	Error storage, Position 2			-	R	4	
362	Past Err3	Error storage, Position 3			-	R	4	
363	Past Err4	Error storage, Position 4			-	R	4	
364	Past Err5	Error storage, Position 5			-	R	4	
365	Past Err6	Error storage, Position 6			-	R	4	
366	Past Err7	Error storage, Position 7			-	R	4	
367	Past Err8	Error storage, Position 8			-	R	4	
368	Past Err9	Error storage, Position 9			-	R	4	
369	Past Err10	Error storage, Position 10			-	R	4	

Set values (readable and writable)								
#	Display	Name, description	min	max	fact. set.	RS 485	Data typ ²⁾	
700	TMP RUTime	maximum run-up time in mins	1	120	8	R/W	1	
701	Switch pnt	Rotation speed switchpoint in %	50	90	80	R/W	1	
703	HVVthrshld	High vacuum pressure switchpoint in mbar	1E-1	5E0	1E-1	R/W	3	
704	TMSheatset	TMS heating temperature set value in °C	30	90	40	R/W	1	
707	TMProt set	Rotation speed set value in rotation speed setting operations in %	20.0	100.0	50.0 ³⁾	R/W	2	
710	BKP off	P _{min} for Interval operations backing pumps [W]	0	1000	0	R/W	1	
711	BKP on	P _{max} for Interval operations backing pumps [W]	0	1000	0	R/W	1	
717	Stbyrotset	Preset rotation speed at standby mode (in %)	20	100	66	R/W	2	
720	Vent frequ	Venting frequency as a % of the final rotation speed of the TMP	40	80	50	R/W	7	
721	Vent time	Venting time in s	6	3600	3600	R/W	1	
738	Gaugetype	Vacuum pressure gauge type			-	R/W	4	
794	Param. set	Parameter set 0 = basic parameter set; 1 = extended parameter set; 2 = operational orientated parameter set	0	2	0	R/W	7	
795	Servicelin	Contains the service line 795 = messages; ≠795 = # of the 2. param. set			795	R/W	7	
797	Address	Unit address	1	255	1	R/W	1	

A number in bold type is a basic parameter set, e.g. "700 TMP RUTime".

☐ = Parameter setting is saved internal and preserves the value if mains is switched off.

1) R = Parameter readable via interface /W = parameter writeable via interface.

2) See Interface instruction "Pfeiffer Protocol to RS 232 and 485" / PM 800 488 BN

3) Function can only be affected via remote plug (X16)

* Parameters are not shown in the LC display but displayed by symbols (line 4) or operable by the keys.

5.3. Parameter overview, operation oriented

#	Display	Name, Description	min	max	fact. set.	RS 485	Sect.
Run up time and switch point							
004	RUTime ctr	Run-up time monitoring ON/OFF	OFF	ON	ON	•	-
700	TMP RUTime	Maximum run-up time in mins	1	120	8	•	6.2.,6.4.
701	Switch pnt	Switchpoint in %	50	90	80	•	6.4.,6.11.
General operating information							
315	TMP finspd	Final rotation speed TMP in Hz			-	•	6.2.,6.5.
310	TMP I-Mot	TMP motor current in A			-	•	6.2.
313	TMP DClk	TMP motor voltage in V			-	•	-
316	TMP power	TMP motor power in W			-	•	-
311	TMP Op hrs	Operating hours TMP in h			-	•	-
Operating adjustment turbopump							
010	Pump stat	Pumping Station ON/OFF	OFF	ON	OFF ³⁾	•	-
023	Motor TMP	Motor Turbopump	OFF	ON	ON ³⁾	•	6.8.
002	Standby	Standby ON/OFF	OFF	ON	OFF ³⁾	•	6.3.
717	Stbyrotset	Preset rotation speed at standby mode (in %)	20	100	66	•	6.3.
026	OpMode TMP	Operations mode TMP 0=final rotation speed operations; ; 1=rotation speed setting mode	0	1	0	•	6.9.
027	gas mode	Operations mode 0=heavy nobel gases; 1=other gases	0	1	0	•	6.7.
707	TMProt set	Rotation speed set value in rotaion speed setting operations in %	20.0	100.0	50.0 ³⁾	•	6.5.,6.9.
308	Set rotspd	Set rotation speed TMP in Hz	0	1000	-	•	-
309	Act rotspd	Actual rotation speed TMP in Hz	0	1000	-	•	-
013	Brake enab	Pre-selection brake 0=off; 1=on	OFF	ON	OFF	•	6.12.
Heating/cooling turbopump							
335	Heat type	Heating typ 0=conventional heating, 1=TMS, 2=cooling	0	255	-	•	6.6.,6.7.
001	Heating	Pre-selection, heating. 0=OFF; 1=ON	0	1	0 ³⁾	•	6.4.,6.5.
704	TMSheatset	TMS heating temperature set value in °C	30	90	40	•	6.5.
331	TMS ActTmp	TMS heating actual value in °C			-	•	6.5.
333	TMS steady	TMS regulator engaged ON/OFF	OFF	ON	-	•	6.5.
334	TMS maxTmp	Maximum TMS temperature occurred in °C			-	•	6.7.
Vent valve controlling turbopump							
012	Vent enab	Venting release turbopump ON/OFF	OFF	ON	ON	•	6.14.
030	Vent mode	Venting mode 0=automatic venting ; 1=do not vent; 2=venting "On"	0	2	0(*)	•	6.14.
720	Vent frequ	Venting frequency as a % of the final rotation speed of the TMP	40	80	50	•	6.5.,6.14.
721	Vent time	Venting time in seconds	6	3600	3600	•	6.14.
Pumping station with TCS							
025	OpMode BKP	Operations mode backing pump, 0=non-stop operations; 1=intermittent operations	0	1	0	•	6.10.
710	BKP off	P _{min} for Interval operations [W]	0	1000	0	•	6.10.
711	BKP on	P _{max} for Interval operations [W]	0	1000	0	•	6.10.
738	Gaugetype	Vacuum pressure gauge type			-	•	6.10.
703	HVVthrshld	High vacuum pressure switchpoint in mbar	1E-1	5E0	1E-1	•	6.10.
340	Pressure	Actual pressure value in mbar	1E-12	1E3	-	•	6.10.
Others							
018	Conf OUT3	Config. 1=casing heating, 2=TMS, 3=air cooling, 0=no function	0	3	0	•	6.4.,7.0.
019	Conf. OUT2	Config. K2 0= open if mains OFF or failure, 1=dto. or warnings 2=open if mains OFF, turbo drive OFF or failure	0	2	0	•	3.10.
024	Conf. OUT1	Configuration output K1 0=switchpoint attained; 1= TMS temperature attained (±5K); switchpoint attained + turbo drive "ON"	0	1	0	•	3.10.,6.5.
028	OpMode rem	Remote Operations mode 0=Standard operations, 1=Latch operations-(Remote Priority; Pin X16.7 set to 1)	0	1	0	•	6.13.
031	HiFlowCtrl	Monitoring rotor lifting in case of high gas flow; 0="OFF", 1="ON"	0	1	0	•	6.2.
303	Error code	Actual error code „no Err“, „Errxxx“ oder „Wrnxxx“			-	•	4.4.
312	Drv Softw	Software version electronic drive unit			-	•	8.0.
794	Param. set	Parameter set 0=basic parameter set; 1=expanded parameter set; 2 = operational orientated parameter set	0	2	0	•	6.2.,6.14.
795	ServiceLin	Contains the service line 795=messages; #795=# of the second parameter set			795	•	4.2.
797	Address	Unit address	1	255	1	•	6.15.
Table of failures							
360	Past Err1	Error storage, Position 1 (last visible failure)			-	•	7.
361	Past Err2	Error storage, Position 2			-	•	7.
362	Past Err3	Error storage, Position 3			-	•	7.
363	Past Err4	Error storage, Position 4			-	•	7.
364	Past Err5	Error storage, Position 5			-	•	7.
365	Past Err6	Error storage, Position 6			-	•	7.
366	Past Err7	Error storage, Position 7			-	•	7.
367	Past Err8	Error storage, Position 8			-	•	7.
368	Past Err9	Error storage, Position 9			-	•	7.
369	Past Err10	Error storage, Position 10			-	•	7.

(*) Function can only be affected via remote plug (X16)

- Function can be called by RS 485

6. Operations

6.1. Switching On The Magnetic Bearing Controller

- ➔ Switch on the unit with switch S1 on the rear side of the unit.

Self-Testing

The TCM 1601 carries out a self test. This is identifiable on the LC display with «**SELF**». After the end of the self test the unit is switched on. The duration of the self-test is maximum 10s. If, when switching on mains power, the rotation speed of the turbopump $f > 0$ Hz the self-test is performed as soon as the rotation speed of the turbopump $f = 0$ Hz is attained.

6.2. Switching ON The Pumping Station

Please note:

Before switching on the pumping station set value programming and setting commands (please see section 5.) should be checked for their suitability with regard to the selected pumps and the pumping process.

- ➔ Select «**794: Param. Set**» and set to «**1**»
- ➔ Check set values [P:7xx] and setting commands [P:0xx]

With backing pumps with high volume flow rates ($\geq 16 \text{ m}^3/\text{h}$):

- ➔ Select «**031 : HiFlowCtrl**» and set to «**ON**».
- ➔ The start up of the magnetic bearing is delayed against the switching on of the backing pump.

- ➔ Switch on the Pumping station with key-button **⓪**, alternative via the remote control or via the serial interface.

While the magnetic bearing is being calibrated the display shows «**calibration**» and on completion the turbopump begins to rotate. During the preselected run up time [P:700], the rotation speed switch point [P:701] must be attained. If an error is identified the LC will display the appropriate error code (please see section 7. "Error Codes And Warnings").

Where backing pumps with high volume flow rates ($\geq 16 \text{ m}^3/\text{h}$) are involved the strong gas flow at the beginning in the turbopump can affect the magnetic bearing and can lead to a malfunction. With [P:031] = «**ON**» this will be checked before the activation of the magnetic bearing. During a possible waiting period «**HighPressDly**» will be displayed in the LC display.

When the key **⓪** is used to acknowledge an error the running up time is re-set to the starting value.

Normal Operations, Turbopump

Once the final rotation speed [P:315] has been attained, the motor current [P:310] is set to a value which is dependent on the level of gas throughput and fore-vacuum pressure.

6.3. Standby ON/OFF

- ➔ Select «**002: Standby**»
- ➔ Select «**OFF**» or «**ON**».

Stand-by is recommended during operating breaks of the turbopump. The factory setting is 66,70% of the final rotation speed. The standby rotation speed is changeable.

- ➔ Select «**717: Stbyrotset**».
- ➔ Adjust Standby rotation speed in the range of 20-100%.

Please note:

Stand-by mode is not possible in rotation speed setting mode [P:026 = 1].

6.4. Casing Heating ON/OFF

Activating the casing heating

- ➔ Select «**018: Conf. OUT3**» and set to «**1**».
- ➔ Select «**001: Heating**» and set to «**1**».

The casing heating is switched on and off dependent on the rotation speed switchpoint [P:701]. Falling below the rotation speed switchpoint causes the heating to be switched off. The status of the casing heating is visible via the LC display (please see section 4.2.).

The function "casing heating" can be carried out via the serial interface or remote control.

6.5. Temperature Management Operations (TMS)

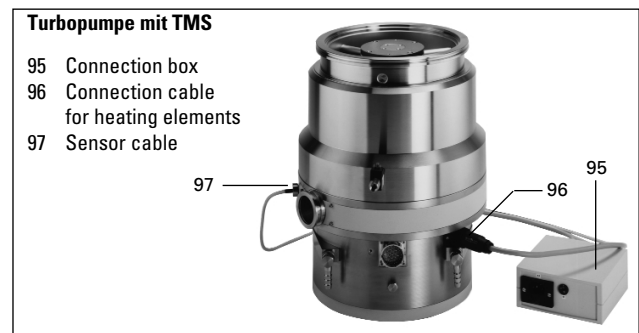

The Temperature Management System (TMS) consists of a controllable heating system which is fitted in the fore-vacuum part of the turbomolecular pump. Heating to a maximum of 90°C prevents the condensation of process gases or by-products in this part of the pump.

To optimise the performance of the pump in gas load operations and to keep the temperature of the pump under control, in TMS operations the rotation speed of the pump is slightly reduced by activating the TMS heating. Specific TMS rotation speeds can be found in the technical data section of the respective pump.

Activating the TMS heating

- ➔ Select «794: Param. Set» and set to «1».
- ➔ Select «018: Conf. OUT3» and set to «2».
- ➔ Select «704: TMSHeatset» and set the temperature.
- ➔ Select «001: Heating» and set to «ON».

The TMS heating is switched on and off contingent on the rotation speed switchpoint [P:701]. The undershooting of the rotation speed switchpoint causes the heating to be switched off. The operations condition of the heating is identifiable by means of a symbol in the LC display (please refer to Section 4.2.).

The TMS heating can be activated and de-activated at any time with [P:001]. In addition to the parameters referred to above, further information/functions which support operations with the TMS are available.

Request TMS temperature

- ➔ Select «331: TMS ActTmp»
- ➔ Read the current temperature.

TMS temperature attained?

- ➔ Select «333: TMS steady»
- ➔ Read display (yes/no).

Function Switch contact K1

The information «333: TMS steady» (TMS set temperature attained) can, in addition, be assigned to the potential-free switch contact with «024: Conf Out1» (please refer to Section 3.10.). It is then available for example for higher level process control.

Please Note:

By pre-selecting [P:001] «heating» to «1» the following parameters are influenced by a reduction of the final rotation speed:

- [P:315] in final rotation speed operations.
- [P:707] in rotation speed setting operations.
- [P:720] in automatic venting mode.

As a matter of principle the TMS heating is only activated once the rotation speed switchpoint [P:701] is attained.

6.6. Air Cooling ON/OFF

Activating the air cooling:

- ➔ Select «018: Conf Out3» and set to «3».

The air cooling is switched on and off contingent on the rotation speed of the pump. Rotation speeds greater than 0 Hz cause the air cooling to be switched on. At 0 Hz the air cooling is switched off.

6.7. Gas Type Dependent Operations

To protect the rotors against overheating the maximum power on some turbopumps is limited to the nominal rotation speed. As a general rule however, with lower pre-selected rotation speeds more power is provided. This frequency/power curve is dependent on the type of gas.

Select gas mode

- ➔ Select «794: Param. Set» and set to «1».
- ➔ Select «027: gas mode».
- ➔ Select «0» for heavy inert gas, «1» for other gases.

The rotation speed is reduced on non-attainment of the gas dependent maximum power until the permissible power and gas friction levels are in balance. To avoid rotation speed fluctuations it is recommended in rotation speed setting operations to set a balance frequency or even a slightly lower frequency (please see Section 6.10.).

The values A, B, C and D are stated in the technical data section of the pump operating instructions.

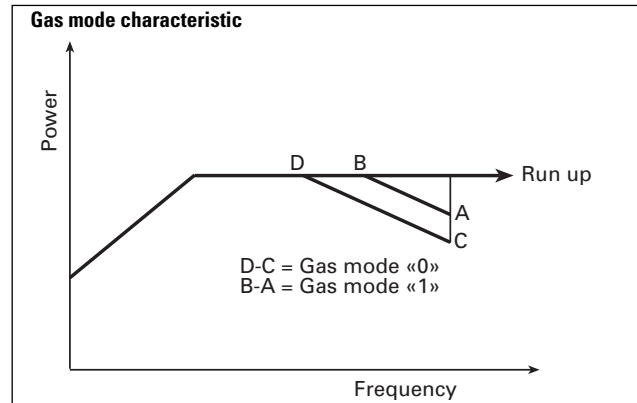

6.8. Switching ON/OFF the turbopump

During pumping station operations the turbopump can be switched off and on separately:

- ➔ Select «023: Motor TMP».
- ➔ Select «OFF», or «ON».

6.9. Rotation Speed Setting Operations

The rotation speed setting operation is selected if the volume flow rate of the turbopump should be reduced. The pressure ratio of the pump reduces exponentially with the rotation speed.

Rotation speed settings in rotation speed setting operations

- ➔ Select «794: Param. Set» and set to «1».
- ➔ Select «707: TMProt set».
- ➔ Adjust rotation speed in the range of 20-100%.

Operation mode turbopump

- ➔ Select «026: OpMode TMP».
- ➔ Select rotation speed setting operations «1».

Remark

The electrical brake can be used for faster reduction of the rotation speed (see chapter 6.11.).

The stand-by mode is ineffective in rotation speed setting operations. The rotation speed switchpoint is fixed at 20% of the final rotation speed.

Rotation Speed Setting Operations Via Input PWM

The provision of a pulse width modulated signal (PWM) on X16:3 enables the rotation speed to be set in the range 20%-100% of the nominal rotation speed.

Ground frequency: 100 Hz ($\pm 20\%$)
 Amplitude, maximum: 33 V
 Pulse-width repetition rate: 25-75%

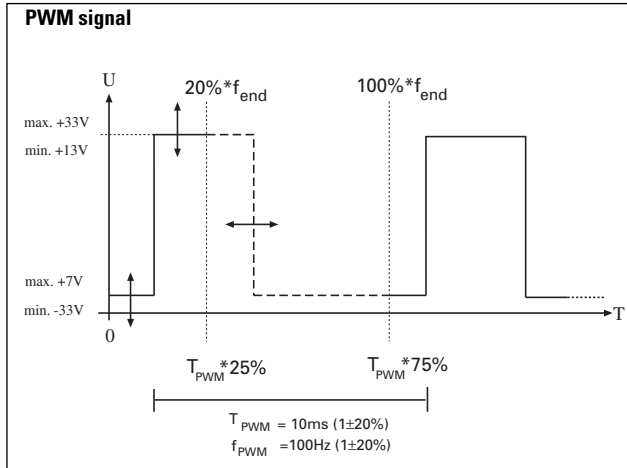

In the event there is a static or a PWM signal with a frequency from <80 Hz or >120 Hz on X16:3, the pump runs up to its final rotation speed.

The PWM signal can be generated with a PWM box (please refer to Section 12, "Accessories"). Control here is executed with 0-10 VDC.

6.10. Operations With The Pumping Station Control Unit TCS 180

The following pumping station components can be controlled with the Pumping Station Control Unit TCS 180:

- Turbopump
- Backing pump (continuous/intermittend operation)
- Fore-vacuum safety valve
- High vacuum valve
- High vacuum pressure gauge

For a description of the function of Pumping Station Control Unit TCS 180 please refer to the Operating Instructions PM 800 384 BN.

Pressure Measurement

With the use of a HV pressure gauge (please see the table in Section 3.11.) the pressure in the vacuum chamber is displayed on the TCM 1601.

Inquiry of the gauge type

- ➔ Select «794: Param set», set to «1».
- ➔ Select «738: gauge type».
- ➔ Read off the gauge type.

Some pressure gauges can be recognised as groups (for example the ACR 261 to 263) and have to be adjusted manually.

Request pressure set value

- ➔ Select «794: Param set», set to «1».
- ➔ Select «340: Pressure».
- ➔ Read off the pressure set value [mbar].

Depending on the pressure gauges which are connected, the following displays can appear:

Display (expl.)	appears on
«--- mbar»	no pressure gauges connected
«<5E-4mbar»	non-attainment of the measurement range (dependent on the type of gauge in operation)
«>1E3mbar»	measurement range is exceeded (dependent on the type of pressure gauge in operation)
«6.3E-9mbar»	valid pressure value
«idfam mbar»	pressure gauge type not yet identified; -->set --type
«TPR250»	pressure gauge type TPR 250 connected
«ACR..?»	pressure gauge types ACR 261, ACR 262 or ACR 263 connected and not yet selected (in this case display is «id fam» [P:340])
«Error!»	pressure gauge malfunction

High Vacuum Valve Control

Controlling the high vacuum valve via pump rotation speed and HV pressure measurement protects the magnetic bearing pump from sudden rises in pressure and the process charge in the event of a breakdown. The pump rotation speed and an adjustable high vacuum pressure threshold serve as the control parameters.

If operation of the high vacuum valve is released via the TCS 180, the valve can be opened or closed by a switch in the feed line.

The switch must be installed by the customer.

- ➔ See also wiring diagram PM 041 892 -S, section 11, connection X13, PIN 1 to the high vacuum valve.

Adjustment pumping speed and HV pressure threshold

- ➔ Select «794: Param set», set to «1».
- ➔ Select «701: Switch pnt» «50....90%».
- ➔ Select «703: HVVthrshld»
- ➔ Adjust « $1 \cdot 10^{-1}$.. $5 \cdot 10^0$ [mbar]».

Operation high vacuum valve

The operation of the HV valve in conjunction with the pumping station status and the valve status is described in Operating Instructions PM 800 384 BN for the TCS 180.

Operation Backing Pump

Depending on the selected backing pump and the vacuum application the operations mode "non-stop operations" or "intermittent operations" can be selected. Intermittent operations are used to increase the working life of the diaphragms in diaphragm backing pumps. The backing pump is switched on and off depending on the take-up power of the turbopump.



Rotary vane pumps must not be used for internal operations.

Non-stop operations backing pump

- ➔ Select [P:794] «Param set» and set to «1».
- ➔ Select [P:025] «OpMode BkP» and set to «0» for non-stop operations.

Interval operations backing pump

- ➔ Select [P:794] «Param set» and set to «1».
- ➔ Select [P:025] «OpMode BkP» and set to «1» for interval operations.

For intermittent operations involving the backing pump a pumping station control unit TCS 180 should be used. The backing pump is switched on and off in accordance with the power take-up levels of the turbopump.

Differing power take-up levels on an idling turbopump lead to differing pressure switchpoints on various pumps. In addition, on diaphragm pumps there are differing final pressures resulting from the gas ballast equipment. This means that ideal pressure switchpoint setting via the power take-up level is not possible. Nevertheless, the advantage of intermittent operations can still be exploited by setting the pressure switch thresholds individually. In this respect operations between 5 and 10 mbar are recommended.

Setting the switching thresholds

- ➔ Select [P:340] «Pressure».
- ➔ Admit air into the fore-vacuum line with the dosing valve while the pumping station is running until the fore-vacuum pressure increases to 10 mbar.
- ➔ Select [P:316] «TMP power».
- ➔ Read off the take-up power at 10 mbar.
- ➔ Select [P:711] «BKP Pon».
- ➔ Save the read-off take-up power as the upper switching threshold.
- ➔ Proceed analogically with the lower switching threshold. Take 5 mbar as the pressure value.
- ➔ Select [P:710] «BKP Poff».
- ➔ Save the read-off take-up power as the lower switching threshold.

6.11. Switching Off The Pumping Station

- ➔ Press key-button  on the front panel. As an alternative, the pumping station is switched off via the remote control or the serial interface.

After switching off, the rotation speed is reduced to 0 Hz and the magnetic bearing is switched off.

6.12. Switch On The Electrical Brake

With an electrical brake the pump can be braked rapidly from the rated rotation speed to 0 Hz. Braking from the rated rotation speed to 200 Hz is with constant power. From 200 Hz to 0 Hz braking is via a motor coil short cut.

- ➔ Select «794: Param set», set to «1».
- ➔ Select «013: Brake enab».
- ➔ Select «ON».

6.13. Remote Control



The pump re-starts automatically after restoration of power after a mains power failure.

Following functions can be switched on and off via remote control (see also the table on section 3.9.)

- Heating "ON/OFF"
- Standby "ON/OFF"
- Pumping station "ON/OFF"
- Turbopump "ON/OFF"
- Reset
- Venting release "ON/OFF"
- Remote priority "ON/OFF"

Operations Modes With The Remote Control

Basically there are three remote control options with differing priorities of the remote control functions:

Standard remote operations

- ➔ Select «028: OpMode rem» to «0».

The individual functions which are operable via the remote control are activated via "SPC high level"*. Individual functions activated via the serial interface cannot be altered via the keyboard or the serial interface. Individual functions de-activated via the remote control can be operated via the serial interface or the keyboard.

*) SPC high level: +13V bis +33V
SPC low level: -33V bis +7V
Ri: 7kΩ

Remote Control Priority "ON"

Where certain application situations are involved, for example SPC control, the remote control functions can be assigned prioritized switching.

With f=0Hz:

- ➔ Select «028 : OpMode rem» and set to «1».
- ➔ Make a bridge from X16.7 to X16.1.
- All set functions are switched off.
- The remote control functions can only be set via X16. The keyboard and the serial interface are inactive.
- The set values are saved.

The functions

- Motor TMP "ON/OFF"
- Heating "ON/OFF"
- Standby "ON/OFF"
- Pumping station "ON/OFF"
- Reset
- Venting release ON/OFF

are activated with "SPC high level" and deactivated with "SPC low level". In the rotation speed setting mode set values are processed exclusively via X16.3.

If X16.7 should be set to "SPC-Low":

- The values set via the remote control are assumed.

Remote Control Priority "OFF"

- ➔ Set «028 : OpMode rem» with f=0 Hz to «1»:
- All set functions are switched off.
- ➔ Set pin X16.7 to "SPC-Low".
- Operations are only possible via the keyboard and the serial interface (remote control is inactive).
- Set values are saved.

If «028 : OpMode rem» should be re-set to «0»:

- Values set via the keyboard or the serial interface are assumed and also the values set via the remote control in "SPC High".

6.14. Venting of the pump

Venting is only possible after the pump has been switched off.

Basically there is a delay time of 6 seconds before each venting cycle so as to close any high vacuum valve which may be connected. In a current-less state, the high vacuum valve is closed. In the event of a malfunction venting takes place in accordance with the selected venting mode.

Cyclic venting can proceed in accordance with the operating conditions.

If the self test after switching on the unit fails, the venting valve remains closed.

In the event of a mains power failure, venting does not take place.

Venting release

- ➔ Select «012: Vent enab», set to «ON».

Three venting modes can be selected in the extended parameter set:

- ➔ Select «794: Param set», set to «1».
- ➔ Call «030: Vent mode», select «0», «1» or «2».

Venting mode «0»: automatic venting

Automatic venting means that venting begins at a set frequency [P:720] for a set duration [P:721].

- ➔ Select «720: Vent frequ».
- ➔ Adjust venting frequency between «40..80%».
- ➔ Select «721: Vent time».
- ➔ Adjust venting time.

Where the pumping station is "OFF" if the turbopump once attains more than 15% of the final rotation speed and then does not attain the venting frequency, venting will take place for the duration of the set venting time.

After "Mains Power ON", the venting valve is closed.

Venting mode «1»: Venting OFF

- > Venting does not take place.

Venting mode «2»: Venting ON

- > In case of "Pumping Station OFF" or in case of a failure venting takes place. The venting valve remains open during mains "ON" (S1). It closes by switching on the pumping station.

6.15. Serial Interface RS 485 Operations

The group address of the TCM 1601 is 988. All units connected to the bus must have differing serial interface addresses [P:797]. The connection of an RS 232 (for example a PC) is possible via Level Converter (see accessories, chapter 12.).

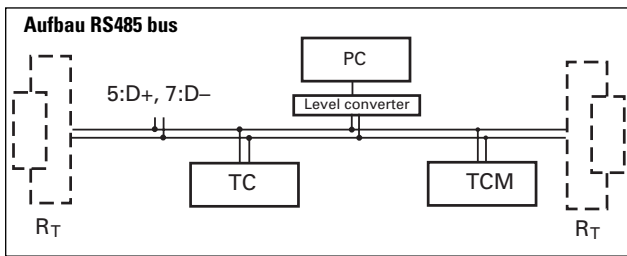

The description of the data communication can be found in Operating Instructions PM 800 488 BN.

6.16. Emergency Current Operations

If the mains power supply fails during operations the magnetic bearing controller is supplied by the back-up current electronic unit. The mains power supply failure is indicated by a blinking green LED on the front panel and a warning message «F007».

If the rotor energy is no longer sufficient to supply the magnetic bearing electronic unit, the rotor is deposited into the safety bearing and is braked as a result of a motor short circuit. Simultaneously all displays on the TCM are deleted.

If mains power is restored before the rotor is deposited the pump is re-accelerated to its nominal rotation speed. If mains power is restored after deposition (but the rotor is still turning) there is a waiting period of $f=0\text{Hz}$ (during this time the magnetic bearing controller is inactive). Then the TCM 1601 carries out a self test and the pump starts again.

6.17. Emergency Current Operations With Battery Box TBB 001

The battery box TBB 001, connected to X29, takes over the supply for the magnetic bearing controller. Subsequently the motor brake brings the rotor to rest within a short time. On deposition of the rotor the battery box is switched off.

The level of charge in the batteries is checked by the TCM 1601 before each time mains power is switched on and every 2 hours during operations. If, in the event of a mains power failure, the capacity of the batteries is insufficient to supply the magnetic bearing to 0 Hz the warning message «F006» (Battery capacity too low) appears in the display.

Batteries are charged with a maximum of 1A with the battery box TBB 001. Empty batteries are fully charged within approximately 2.5 hours.

A replacement of the complete battery box TBB 001 is possible while the turbopump is running. The warning message «F008» can be acknowledged after the battery box has been replaced. Subsequently there follows a once only capacity test on the battery box.

7. Errors And Warnings

#	Meaning	arises when	when resettable	Troubleshooting
«Error Exxx»				
E001	Excess rotation speed TMP	B	Pump at rest	PFEIFFER service
E006	Start-up time error	B	any time	Adjust run up time correctly, open fore vacuum valve Remove the leak, reduce fore vacuum pressure
E014	In the self test recognized heating rate is modified by pulling the plug or malfunction	B	any time	Change the heating or cooling configuration PFEIFFER service
E016	Brake reduction current defective	B / S	Pump at rest	Test magnetic bearing controller, PFEIFFER Service
E017	Non-conformity in the setting of switching output 3 [P:018] and the installed heating system	B / S	any time	Check setting [P:018]. Check the electrical connections to the TMS box/casing heating/air cooling.
E020	Emergency current supply malfunction	B / S	Pump at rest	Test magnetic bearing controller, PFEIFFER Service
E021	Unknown pump connected	B / S	Pump at rest	Test pump and cable, PFEIFFER Service
E022	Pump cable not connected or resistance impedance supply defective	B / S	Pump at rest	Plug in pump cable PFEIFFER service
E033	+15V malfunction	B / S	Pump at rest	Test magnetic bearing controller, PFEIFFER Service
E034	Motor voltage +70V malfunction	B	Pump at rest	Test magnetic bearing controller, PFEIFFER Service
E040	RAM module defektive	S	not resettable	Test magnetic bearing controller, PFEIFFER Service
E041	ITRIP Motor current too high	B / S	Pump at rest	Test magnetic bearing controller, PFEIFFER Service
E043	Data storage malfunction	B / S	not resettable	Test magnetic bearing controller, PFEIFFER Service
E050	Excess temperature magnetic bearing amplifier	B	any time	Keep to the ambient conditions Test magnetic bearing controller, PFEIFFER Service
E051	Vent valve defective or not connected	B	any time	Test the vent valve, PFEIFFER Service
E052	Watchdog TMS320	B	Pump at rest	Test magnetic bearing controller, PFEIFFER Service
E062	Magnetic bearing X unstabil	B	Pump at rest	Test the pump or call PFEIFFER Service
E063	Magnetic bearing Y unstabil	B	Pump at rest	Test the pump or call PFEIFFER Service
E064	Radial emergency bearing clearance too small	B	Pump at rest	Test the pump or call PFEIFFER Service
E065	Radial emergency bearing clearance too big	B	Pump at rest	Test the pump or call PFEIFFER Service
E066	Lower axial bearing clearance too small	B	Pump at rest	Test the cooling, reduce the gas load, PFEIFFER Service
E067	Lower axial bearing clearance too big	B	Pump at rest	Test the pump or call PFEIFFER Service
E068	Upper axial bearing clearance too small	B	Pump at rest	Test the pump or call PFEIFFER Service
E069	Upper axial bearing clearance too big	B	Pump at rest	Test the pump or call PFEIFFER Service
E070	Axial bearing unstabil	B	Pump at rest	Test the pump or call PFEIFFER Service
E072	Axial bearing current too low	B	Pump at rest	Test the pump or call PFEIFFER Service
E073	Axial bearing current too high	B	Pump at rest	Test the pump or call PFEIFFER Service
E074	Radial bearing current X different	B	Pump at rest	Test the pump or call PFEIFFER Service
E075	Radial bearing current Y different	B	Pump at rest	Test the pump or call PFEIFFER Service
E078	Axial bearing amplifier defective	B	Pump at rest	Test magnetic bearing controller, PFEIFFER Service
E079	Radial bearing amplifier X defective	B	Pump at rest	Test magnetic bearing controller, PFEIFFER Service
E080	Radial bearing amplifier Y defective	B	Pump at rest	Test magnetic bearing controller, PFEIFFER Service
E082	Pump cable disconnected	B	Pump at rest	Test cable connection, change the cable, if necess.
E086	Sensor voltage X malfunctioning	B	Pump at rest	Test the pump and TCM or call PFEIFFER Service
E087	Sensor voltage Y malfunctioning	B	Pump at rest	Test the pump and TCM or call PFEIFFER Service
E088	Sensor voltage, axial bearing, malfunctioning	B	Pump at rest	Test the pump and TCM or call PFEIFFER Service
E089	Rotor vibrations	B	any time	Reduce vibrations or call PFEIFFER Service
E100	Pressure gauge defective	B / S	Pump at rest	Test the gauge, the cable and the TCM
E101	High vacuum valve bridges not connected	B / S	any time	Put on the bridge plug, test the TCS
E102	High vacuum valve in undefined position	B	any time	Test the end switch, test the TCS
E103	High vacuum valve does not close	B	any time	Test the end switch, test the TCS
E104	Composite error backing pump	B / S	any time	Test the backing pump, test the TCS
E105	TCS disconnected	B	any time	Put on the plug, test the TCS
«Warning Fxxx»				
F001	TMS warm-up time elapsed	B	any time	Test heating cartridges, test the TMS system, PFEIFFER Service
F002	TMS limit temperature attained	B	any time	Test the cooling, test the ambient temperature, PFEIFFER Service
F005	The battery test fuse is defective	B / S	any time	Insert a new fuse in the TBB 001.
F006	Batterie capacity too low	B	any time	Check battery, load battery, PFEIFFER Service
F007	Emergency power operation	B		See sect. .6.17. "Emergency Power Operations"
F008	TBB 001 defective	B / S	any time	PFEIFFER Service
F010	Non conformity setting switch output 3 [P:018] and installed heating system	B / S	any time	Check settings [P:018]. Check electrical connections to TMS box/casing heating/air cooling.

B: can arise during operation
S: can arise during self-testing

8. What To Do In Case Of Breakdowns?

Check The Fuses

In case of defects:

- ➔ Remove F1 and F2 using a screwdriver and check fuses. Replace if defective. The fuse values are printed on the reverse side of the fuse.

Identifying Error Messages

Error messages on the LC display can be identified with the help of the error table (Section 7) and in some cases eliminated.

During operations, the last ten errors and warnings are saved in parameter [P:303] «**Error Code**».

If an error cannot be remedied:

- ➔ Inform PFEIFFER-Service.
- ➔ Describe the error and mention respective error message.

9. Maintenance, Service

The unit requires no maintenance. A damp cloth can be used to wipe away any dirt which has collected on the front panel. Ensure that the unit is first disconnected from the mains power supply.

Do Make Use Of Our Service Facilities

In the event that repairs are necessary a number of options are available to you to ensure any system down time is kept to a minimum:

- Have the unit repaired on the spot by PFEIFFER Service Engineers;
- Return the unit to the manufacturer for repairs;
- Replace with a new value unit.

Local PFEIFFER representatives can provide full details.

When carrying out their own repairs customers must bear in mind that dangerous voltage levels are present. When carrying out own repairs or maintenance work on the units which are in contact with hazardous substances it is important to comply with all relevant safety regulations.

Please note:

Units returned to us for repair or maintenance are covered by our general conditions of sale and supply.

Contact addresses and telephone hotline:

Please refer to the back cover of this manual for contact addresses and telephone hotline numbers.

10. Technical Data

10.1. Data List, Magnetic Bearing Controller TCM 1601

Feature	Unit	TCM 1601
Connection voltage:	V AC	90 - 132 190 - 265
Current:	A	8
Power input:	VA	800
Frequency:	Hz	50-60
Output voltage, motor connection:	V DC	70
Output current, motor connection:		
Mains voltage 190-265 VAC	A DC	7,9
Mains voltage 90-132 VAC	A DC	4,3
Power loss:	Watt	180
Permissible ambient temperature:	°C	5 - 40
Relative humidity, maximum*:	%	5-85
Air pressure:	kPa	86-106
Protection type:		IP 20
Protection class:		I
Potentialfree Kontakts K1, K2		
Switching voltage, maximum:	V DC	SELV ¹⁾
Switching current, maximum:	A	0,5
Switching power, maximum::	W	10
Start-up time, adjustable:	min	8-120
Rotation speed switchpoint:	%	50-90
Cable length, maximum:	m	50
Temperature Management System		
(TMS) / pump temperature:	°C	60-90
Serial interface:		RS 485
Low rotation speed mode, adjustable:	%	20-100
Weight:	kg	8

*non condensing
¹⁾ safety low voltage (26-42 VDC)

10.2. Dimensions

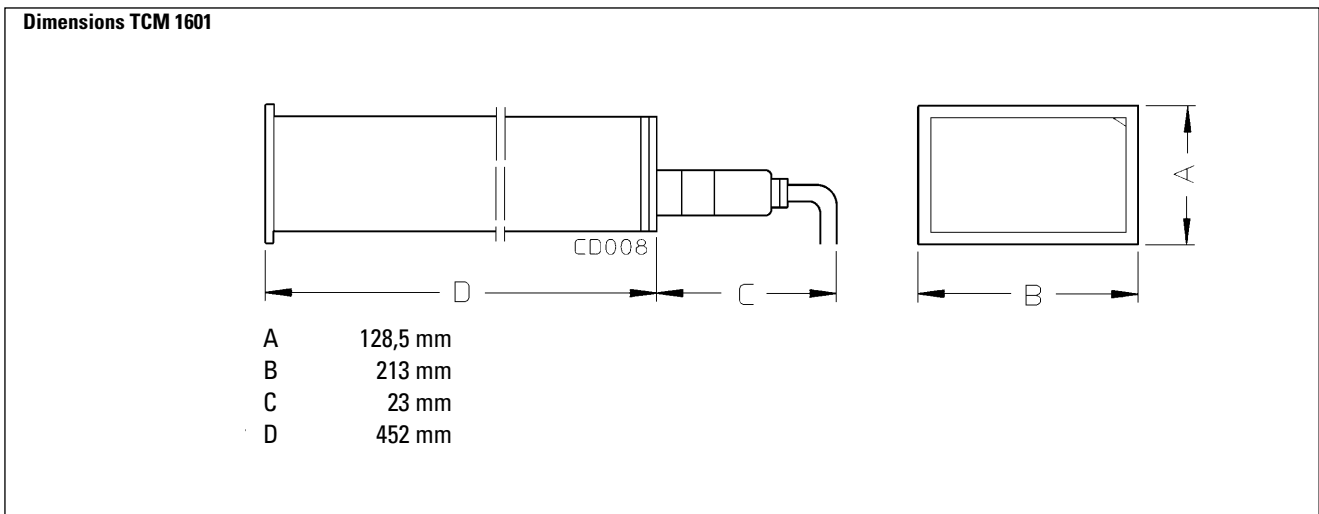

12. Accessories

Description	Size	Number	Operating Instructions	Order Quantity/ Comments
Pumping Station Control Unit TCS 180	100 - 240 V; 50/60 Hz	PM C01 655	PM 800 384 BN	
Mains cable				
- Schuko		P4564 309 ZA		
- US-version	115 V	P4564 309 ZE		
- US-version	208 V	P4564 309 ZF		
Pump cable	3 m	PM 051 003 -T		
Level converter RS 485/RS 232		PM 051 054 -X	PM 800 549 BN	
Battery box TBB 001		PM K 01 712	PM 800 517 BN	
PWM box		PM 051 028 -U		

13. Supplementary Informations

The operating of PFEIFFER magnetic bearing turbomolecular pumps is described in these operating instructions. These operating instructions are an integral part of the complete operating instruction manual for your modular turbopump system. The delivery consignment contains further operating manuals according to the configuration of your components (please see the table).

We make every effort to ensure that you have all the information on our products which is necessary but if you feel you need any further advice, please get in touch with your local Pfeiffer representatives or call us on the hotline shown on the back cover of this manual.

The respective documents are also available in PDF format.

The following operating manuals are available for the pump program:

Product	Definition	Operating Manual Number
Magnetic bearing Turbomolecular Pump	Definition of the turbopump	dependent on the type of pump*
Casing heating, turbopump	Description of the casing heating	PM 800 542 BE
Water cooling, turbopump	Description of the water cooling recycling unit	PM 800 369 BE
Temperature Management System TMS	Description of the TMS installation	PM 800 570 BE
Pfeiffer protocol RS 232/RS 485	Description of the serial interface protocol	PM 800 488 BE
Level Converter RS 232/RS 485	Description of the pumping control via the RS 232	PM 800 549 BE
Venting valve TVF 005	Description of the venting valve	PM 800 507 BE
Pumping station control unit TCS 180	Description of the pumping station control unit	PM 800 384 BE

* The number is available from PFEIFFER Service.



Konformitätserklärung
Declaration of Conformity



im Sinne folgender EU-Richtlinien:
pursuant to the following EU directives:

- **Elektromagnetische Verträglichkeit/Electromagnetic Compatibility 89/336/EWG**
- **Niederspannung/Low Voltage 73/23/EWG**

Hiermit erklären wir, daß das unten aufgeführte Produkt den Bestimmungen der EU-Richtlinie über elektromagnetische Verträglichkeit 89/336/EWG und der EU-Niederspannungsrichtlinie 73/23/EWG entspricht.

We hereby certify that the product specified below is in accordance with the provision of EU Electromagnetic Compatibility Directive 89/336/EEC and EU Low Voltage Directive 73/23/EEC.

Produkt/Product:

TCM 1601

Angewendete Richtlinien, harmonisierte Normen und angewendete, nationale Normen:

Guidelines, harmonised standards, national standards which have been applied:

EN 61010, EN 55011, EN 50081-1, EN 50082-2, IEC 801 1-4, VDE 0843-6

Unterschrift/*Signature:*



Pfeiffer-Vacuum GmbH
Emmeliusstrasse 33
35614 Asslar
Germany

(W. Dondorf)
Geschäftsführer
Managing Director

Zentrale/Headquarters

Pfeiffer Vacuum GmbH

Emmeliusstrasse 33
D-35614 Asslar

Telefon 06441/802-0
Telefax 06441/802-202
Hotline 06441/802-333
Internet:
<http://www.pfeiffer-vacuum.de>

Argentina

ARO S.A., Casilla de Correo 4890,
1000 Buenos Aires, telephone +54 / 1 331 3918,
telefax +54 / 1 331 3572

Australia

Balzers Australia Pty. Ltd., Level 1,
3, Northcliff Street, Milsons Point, NSW 2061,
telephone +61 / 2 9954 1925, telefax +61 / 2 9954 1939

Austria

Pfeiffer Vacuum Austria GmbH
Diefenbachgasse 35, A-1150 Wien,
telephone +43 / 1 8941 704, telefax +43 / 1 8941 707
Service Hotline: +43 / 1 8941704

Branch Office, Czech Republic

Pfeiffer Vacuum Austria GmbH, Branch Prague
Zvonarska 885
CZ-156 00 Praha 5
telephone + 420/2 900 42981
telefax + 420/2 579 23014

Belgium / Luxemburg

Pfeiffer Vacuum Belgium N.V./S.A.
Luxemburgstraat 5, B-1940 Temse
telephone +32 / 3 710 5920, telefax +32 / 3 710 5929
Service Hotline: +32 / 3 710 5922

Brazil

Elmi Tec
Assistencia Técnica e Representação S/C Ltda.
Rua Bernadino de Compos, 551
CEP 04620-002 São Paulo, SP - Brasil
telephone +55 / 11 532 0740
telefax +55 / 11 535 3598

Chile

BERMAT S.A., Coyancura 2283, piso 6
Providencia, P.O. Box 9781, Santiago
telephone +56 / 2 231 8877,
telefax +56 / 2 231 4294

Colombia

Arotec Colombiana S.A., Carrera 15 No.38-17
P.O. Box 050 862, Santafe de Bogota / D.C.
telephone +57 / 1 288 7799, telefax +57 / 1 285 3604

Denmark

Pfeiffer Vacuum Scandinavia AB, Vesterengen 2,
DK-2630 Taastrup,
telephone +45 / 43 52 38 00
telefax +45 / 43 52 38 50

France

Pfeiffer Vacuum France SAS
45, rue Senouque, BP 139 F-78531 BUC Cedex
telephone +33 / (0) 1 30 83 04 00
telefax +33 / (0) 1 30 83 04 04

Germany

Pfeiffer Vacuum GmbH,
Emmeliusstrasse 33, D-35614 Asslar
telephone +49 / 6441 802 400
telefax +49 / 6441 802 399
Service Hotline: +49 / 6441 802 333

Great Britain

Pfeiffer Vacuum Ltd.
2-4 Cromwell Business Centre
Howard Way, Interchange Park
Newport Pagnell, MK16 9QS, United Kingdom
telephone +44 / 1 908 500615
telefax +44 / 1 908 500616

Greece

Analytical Instruments S.A., 1 Mantzarou St.,
GR-15451 Athens,
telephone +30 / 1 674 8973
telefax +30 / 1 674 8978

India

Pfeiffer Vacuum India Ltd.
25-E Nicholson Road, Tarbund
Secunderabad 500 009,
telephone +91 / 40 775 0014, telefax +91 / 40 775 7774

Israel

ODEM Scientific Applications,
2 Bergman Street, Science based park
Rehovod
telephone +972 8 9366 101,
telefax +972 8 9366 102

Italy

Pfeiffer Vacuum Italia S.p.a.
Via San Martino, 44 I-20017 RHO (Milano)
telephone +39 / 2 93 99 051, telefax +39 / 2 93 99 05 33

Japan

Hakuto Co. Ltd., C.P.O. Box 25,
Vacuum & Scientific Instruments Division
Tokyo Central 100-91,
telephone +81 / 3 32 258 910
telefax +81 / 3 32 259 009

Korea

Pfeiffer Vacuum Korea Ltd.,
702 Ho, 853-1, Hankuk Mulru, Dongchonri, Suzi-Eup,
449-800 Yong-in City, Kyungkido
telephone +82 / 31 266 0741
telefax +82 / 31 266 0747

Netherlands

Pfeiffer Vacuum Nederland BV
Veldzigt 30a, NL-3454 PW De Meern,
telephone +31 / 30 6666050, telefax +31 / 30 6662794

Peru

Ing. E. Brammertz s.r.l., José Pardo 182,
Apartado 173, PE-18 Miraflores,
telephone +51 / 1 445 8178
telefax +51 / 1 445-1931

Poland

Softrade Sp.z.o.o, ul. Grunwaldzka 391,
PL-60-173 Poznan, telephone +48 / 61 8677 168,
telefax +48 / 61 8677 111

Portugal

Unilaser Lda, Taguspark
Núcleo Central, sala nº 268, Estrada Cacém-
Porto Salvo, P-2780 Oeiras
telephone +351 / 1 421 7733
telefax +351 / 1 421 7744

Singapore

APP Systems Services Pte. Ltd, 2 Corporation Road
06-14 Corporation Place, Singapore 618494,
telephone +65 / 268 2024, telefax +65 / 268 6621

Spain

Tecnovac
Tecnología de Vacío S.L., Ronda de Poniente, 6 Bajo F
Centro Empresarial Euronova
E-28760 Tres Cantos (Madrid)
telephone +34 / 91 804 11 34,
telefax +34 / 91 804 30 91

Sweden

Pfeiffer Vacuum Scandinavia AB
Johanneslundsvägen 3
S-194 61 Upplands Väsby
telephone +46 / 590 748 10
telefax +46 / 590 748 88

Switzerland

Pfeiffer Vacuum Schweiz S.A.
Förrlibuckstraße 30, CH-8005 Zürich
telephone +41 / 1 444 2255,
telefax +41 / 1 444 2266

South Africa

Labotec Pty Ltd., P.O. Box 6553,
Halfway House
1685 Midrand
telephone +27 / 11 315 5434
telefax +27 / 11 315 5882

Taiwan

HAKUTO Taiwan Ltd. Hsinchu office No. 103,
Hsien Chen 11th Street, Jubei City,
HsinChu County, Taiwan, R.O.C.
(zip/postal code: 302)
telephone +886 / 3 554 1020
telefax +886 / 3 554 0867

Thailand

S & T Enterprises (Thailand) Ltd.
18th Floor, Chokchai Int'l Bldg.
690 Sukhumvit Road
Klongton, Klongtoey
Bangkok 10110
telephone +662 / 259 4623
telefax +662 / 259 6243

U.S.A.

Pfeiffer Vacuum, Inc.
24 Trafalgar Square
Nashua, NH 03063-1988
USA
telephone +1/ 603 578 6500
telefax +1/ 603 578 6550

Venezuela

Secotec S.A., Apartado 3452, Caracas 1010-A,
telephone +58 / 2 573 8687
telefax +58 / 2 573 1932

Other countries

AVI - Applied Vacuum Industries GmbH
Leginglenstrasse 17A; CH-7320 Sargans
Switzerland
telephone +41 / 81 710 03 80
telefax +41 / 81 710 03 81

Scope of represented countries

Armenia, Azerbaijan, Bangladesh, Belarus, Bulgaria,
Cambodia, Estonia, Georgia, Hong Kong, Kazakhstan,
Kingdom of Nepal, Kirghizia, Latvia, Lithuania,
Maldavia, Philippines, P.R. China, Rumania, Russia,
Tajikistan, Turkmenistan, Ukraine, Uzbekistan, Vietnam

A.E.M.S.

Advanced Equipment Materials and Systems
P.O. Box 25
Föhrenweg 18
FL-9496 Balzers
telephone +41 / 75 380 0550
telefax +41 / 75 380 0551

Scope of represented countries

Bahrain, Egypt, Iraq, Iran, Jordan, Kuwait, Lebanon,
Lybia, Oman, Pakistan, Saudi-Arabia, Sudan, Syria,
Turkey, United Arab Emirates, Yemen